

DIR[®]

Magic-Double

6112
INSTRUCTION MANUAL

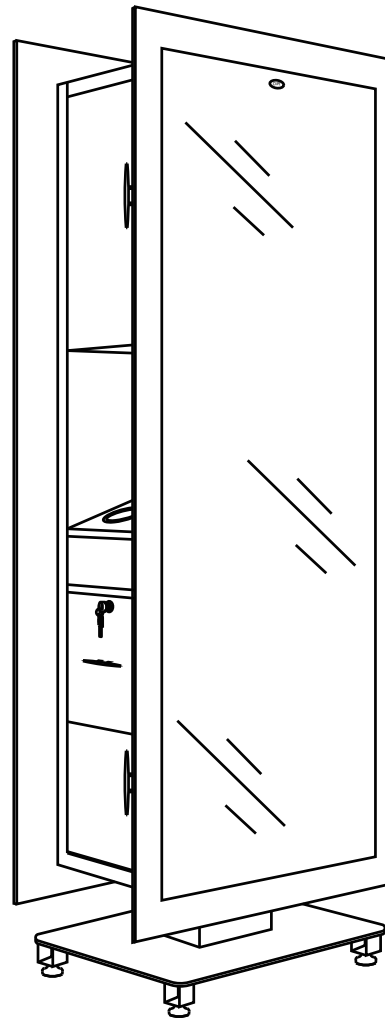

List of Parts & Tools

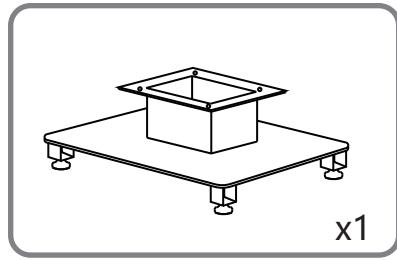

x1

101001

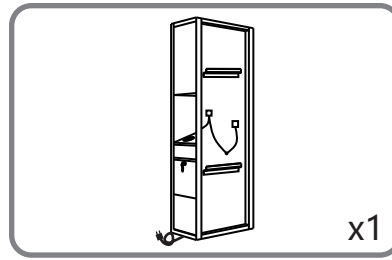

x1

101002

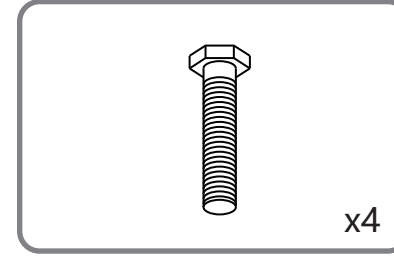

x4

114860

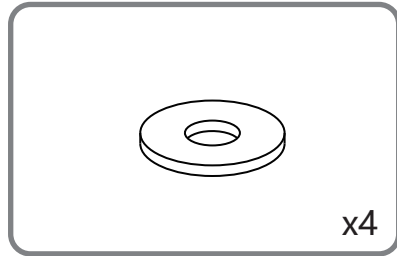

x4

117008

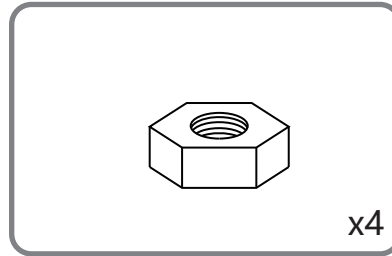

x4

119008

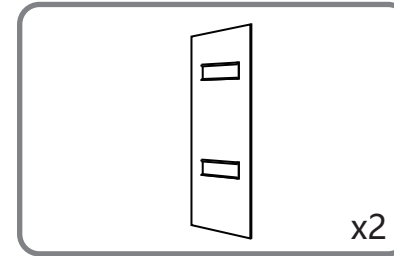

x2

101003

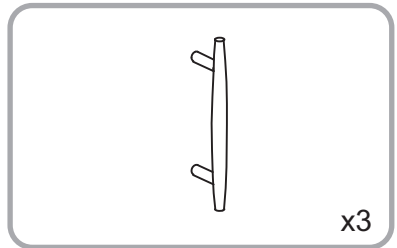

x3

101005

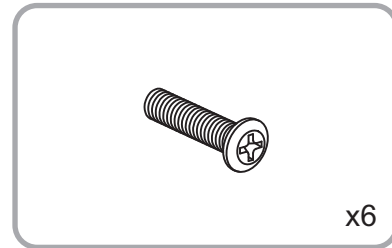

x6

101006

Step 1

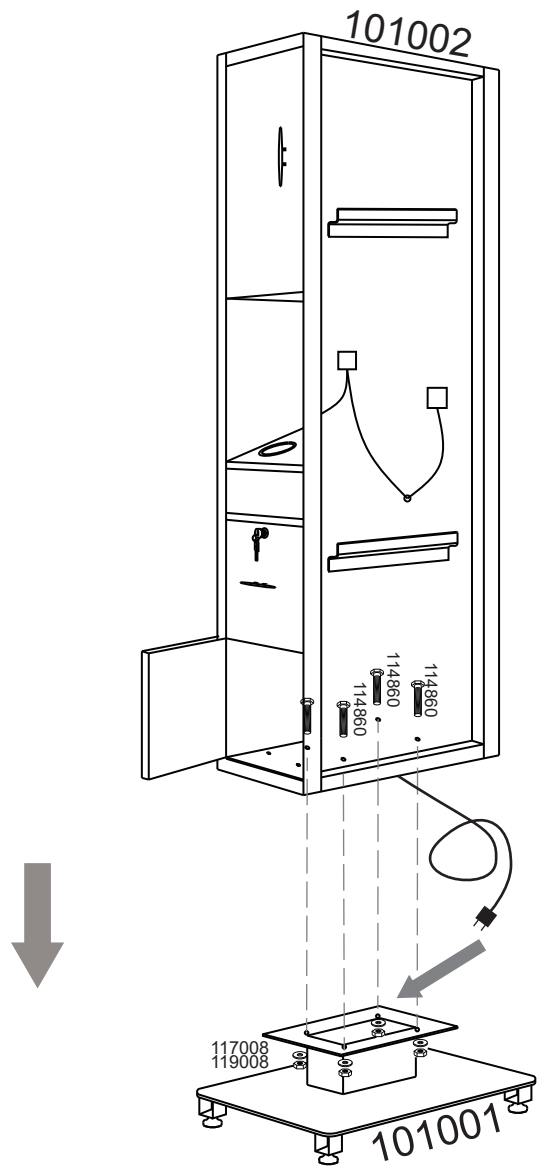

The plug passes through the center of the base.

Step 2

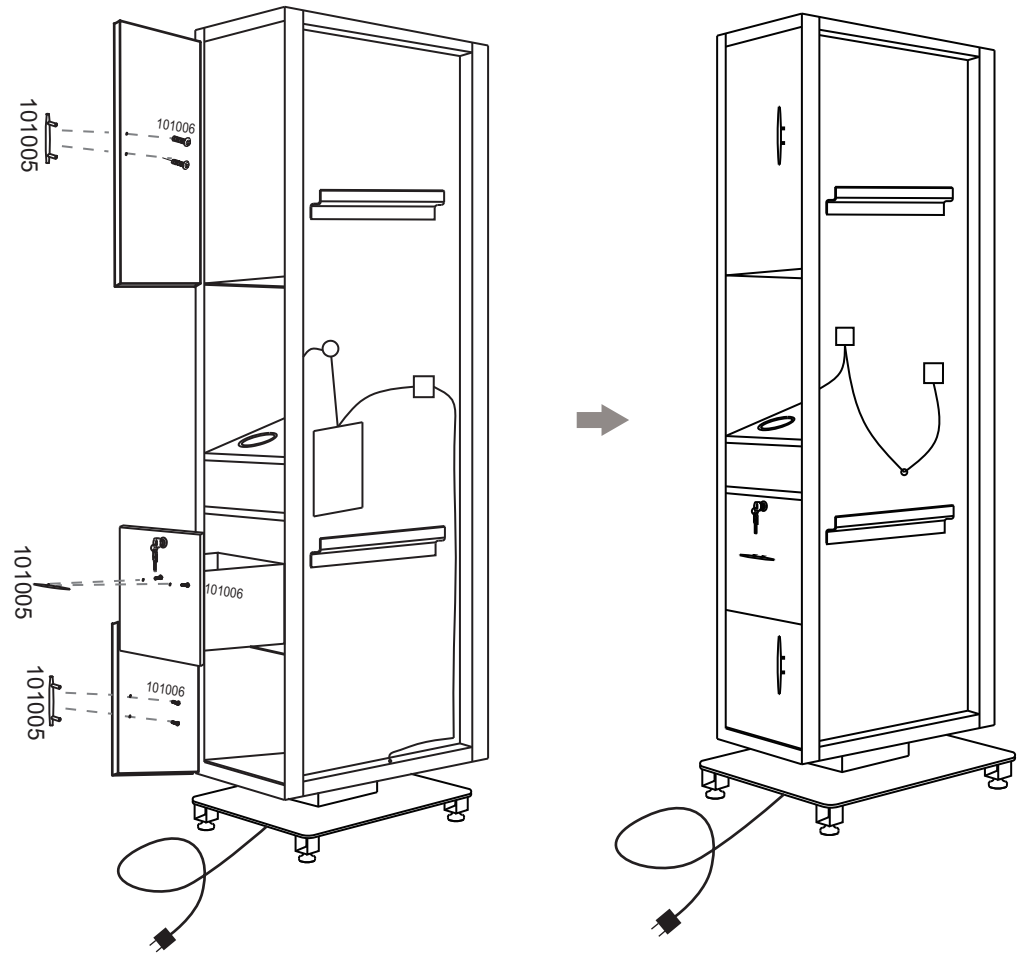

Step 3

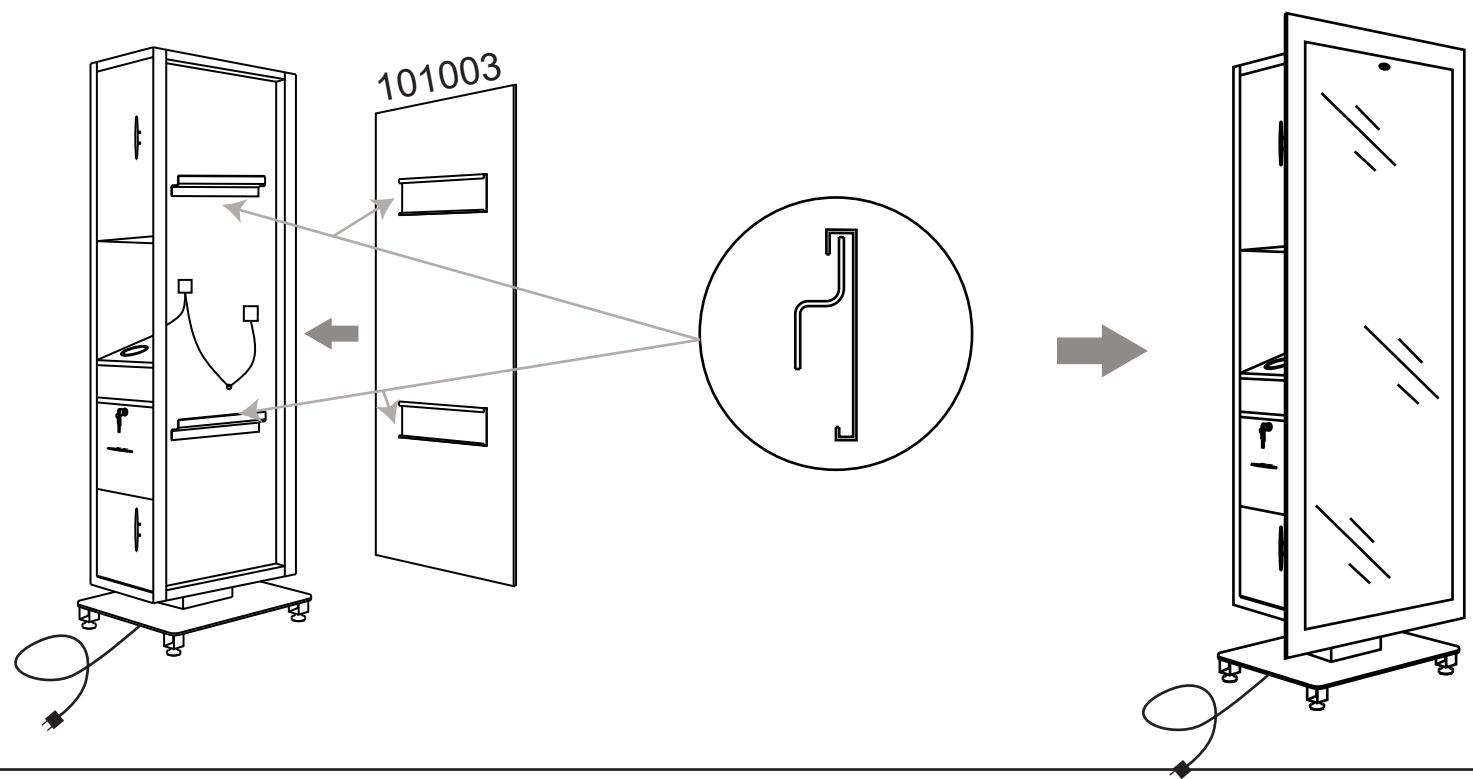

Step 4

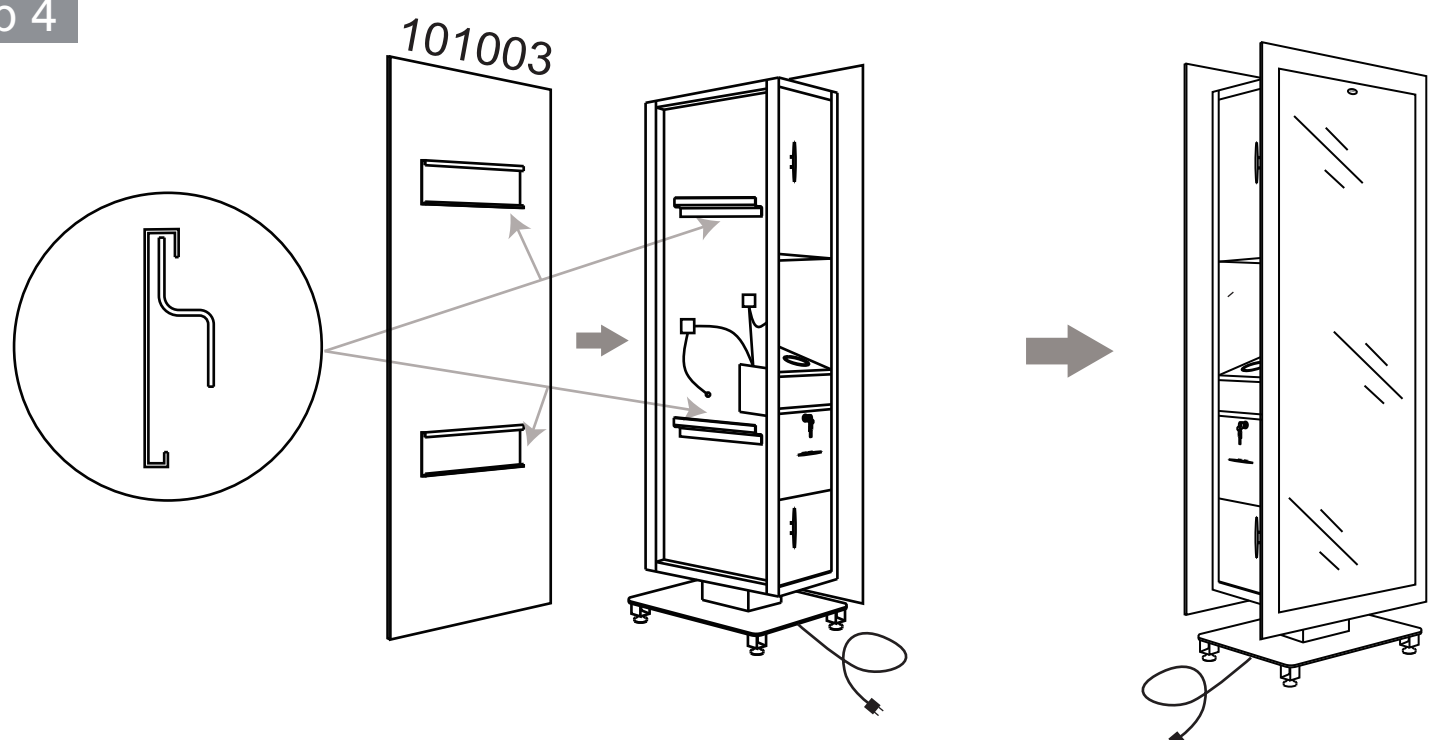

Product care

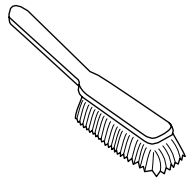

Brush away excess hair

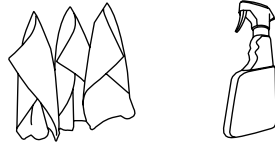

Clean surface with damp cloth or use simple soap & water solution.

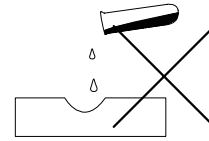

Avoid using corrosive cleaning agents such as bleaches.

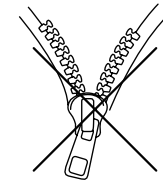

Do not remove upholstery for cleaning

Warranty

The warranty period is one year. DIR warrants to you, the original buyer, that goods shall be free of defects in material and/or workmanship attributable to manufacture for one year from date of receipt of product. Damage resulting from improper handling after merchandise is received, or from exposure to weather or extreme atmospheric conditions is not covered by the warranty. For any other information please contact our support team:

DIR BIRMINGHAM

66 Rea Street South
Birmingham
B5 6LB
UK

Tel:
+44(0)121 6434777

Email:
dirsalon@gmail.com

DIR LONDON

Unit 1 River Road
Business Park
33 River Road, Barking
Greater London
IG11 0DA
UK

Tel:
+44(0)20 8591 9310

Email:
dirsalon@gmail.com

DIR NEW YORK

575 Underhill Blvd.
Suite 170
Syosset, NY 11791
USA

Tel:
+1 (718)628-6668
+1 (800)728-2008

Email:
sales@dirsalonfurniture.com

DIR IRELAND

Unit 20, Goldenbridge Ind.
Estate Tyrconnell Road
Inchicore
Dublin 8
Republic of Ireland

Phone:
+353 (1) 429 7969

Email:
sales.ireland@dirgroup.ie