

DIR

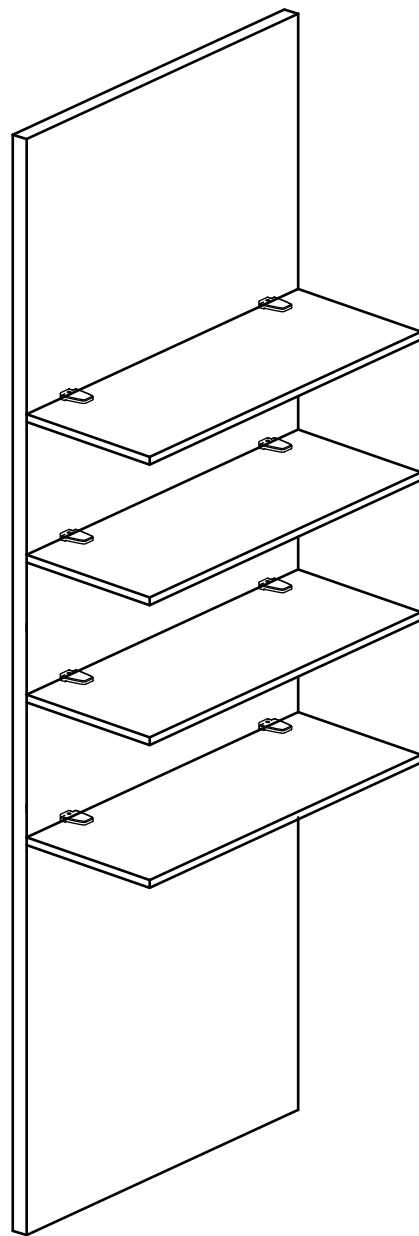

Vina

6801

INSTRUCTION MANUAL

List of Parts & Tools

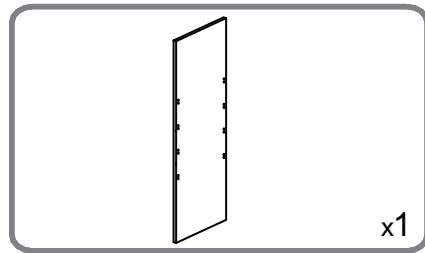

101001

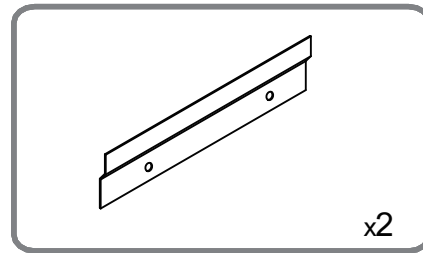

101002

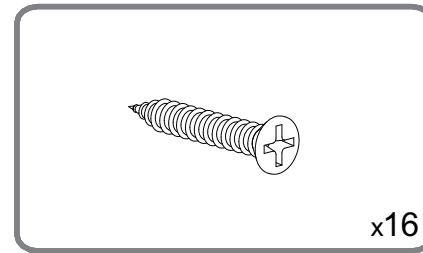

101003

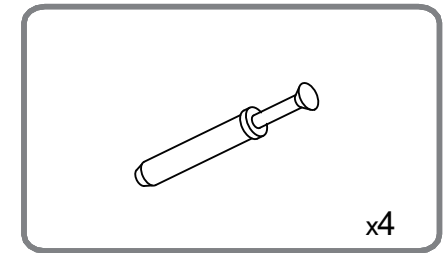

101004

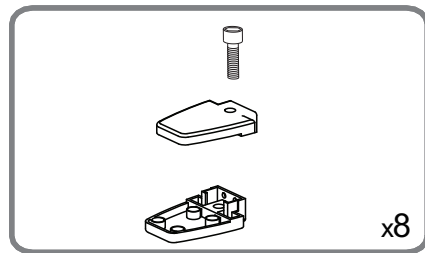

101005

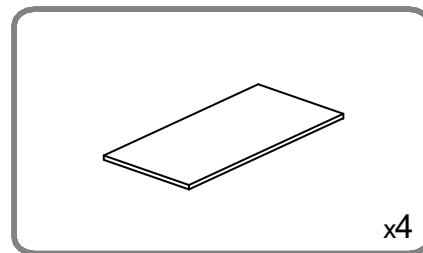

101006

Step 1

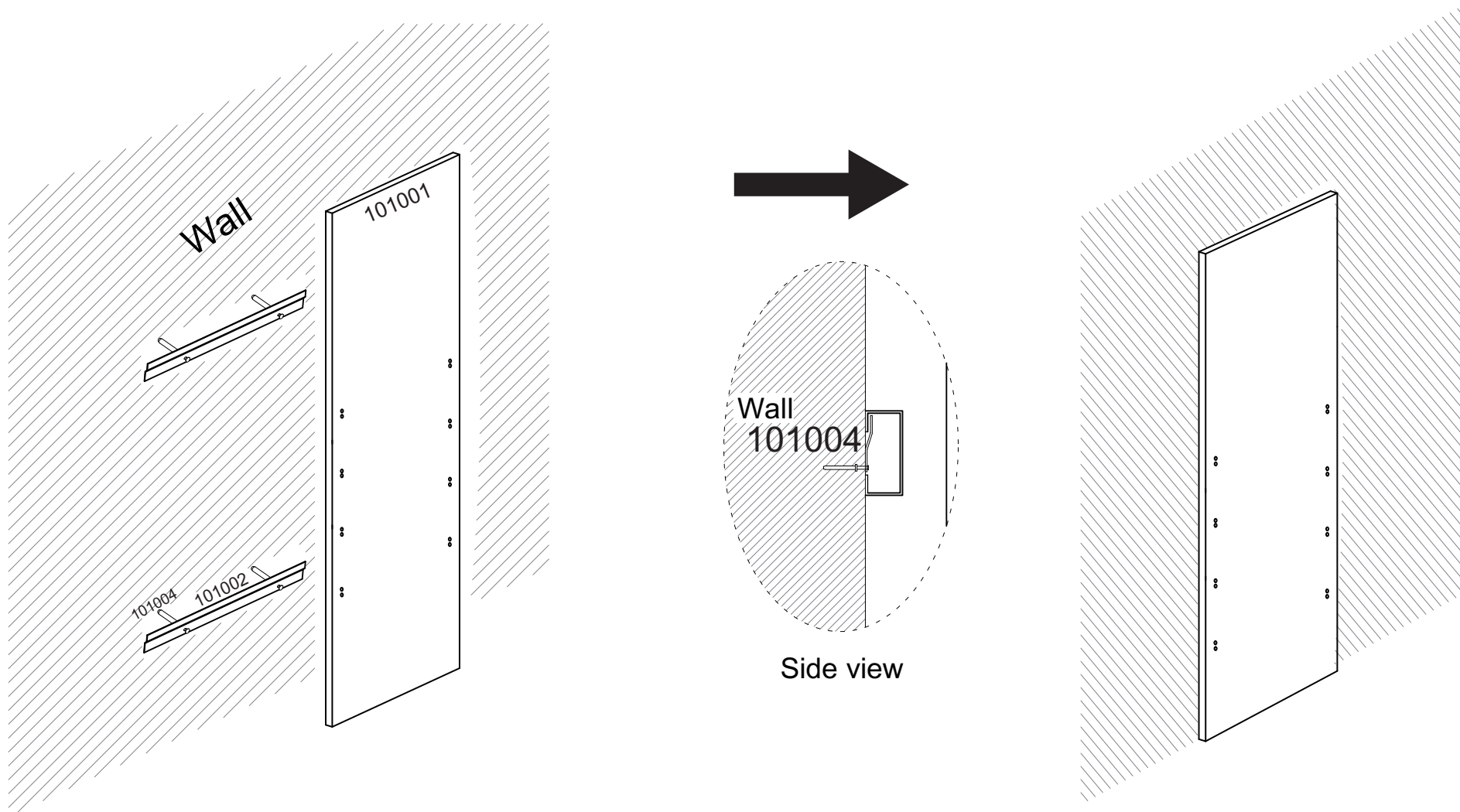

Secure the bracket onto the wall with provided expansion bolts, then secure the mirror onto the metal bracket. DIR's expansion bolts are meant for solid (cement or solid wood) walls, please use appropriate expansion bolts or wall anchors for your mounting needs. the

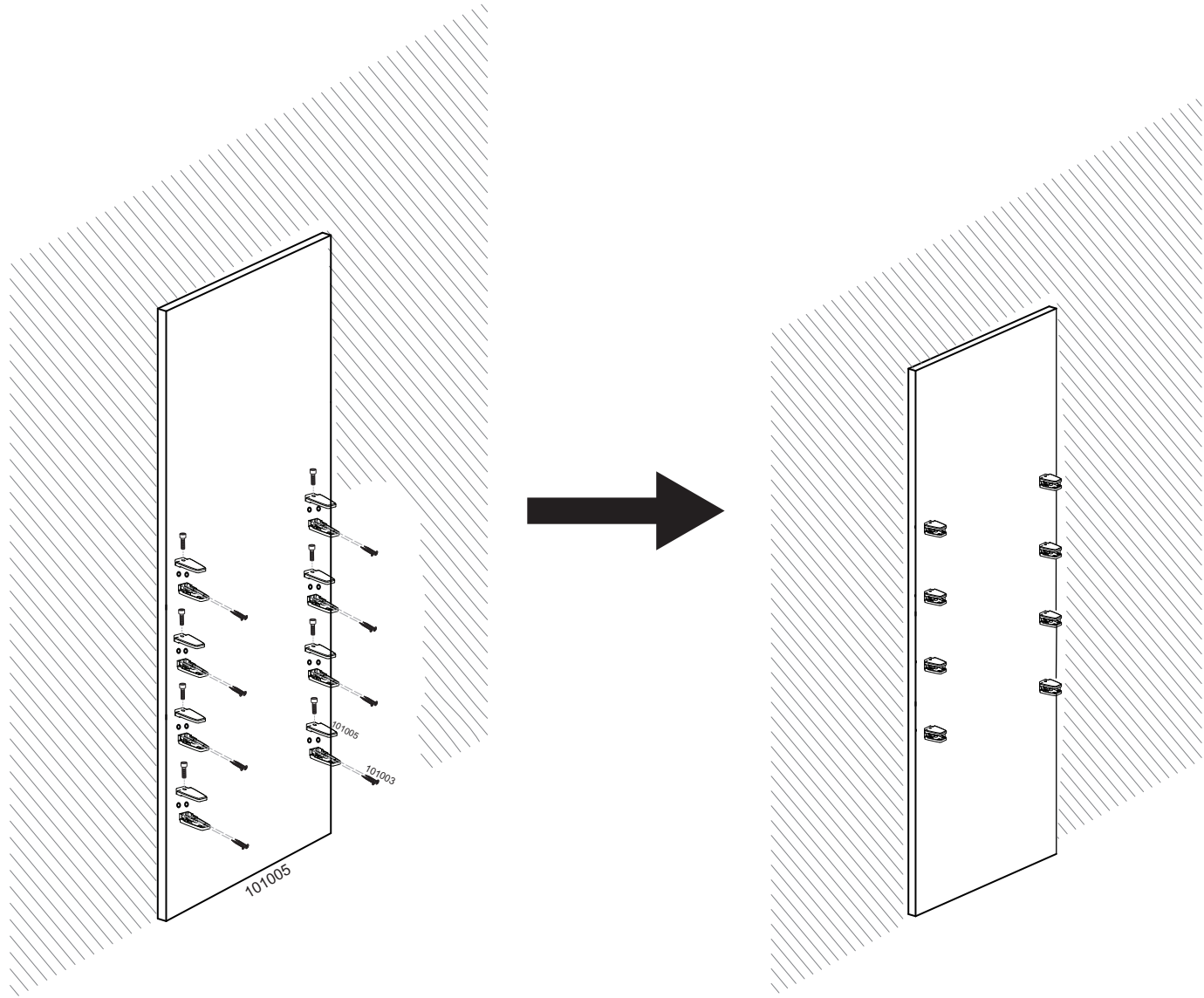

Insert platform into the Glass and then fixed it in the back of the mirror with screw.

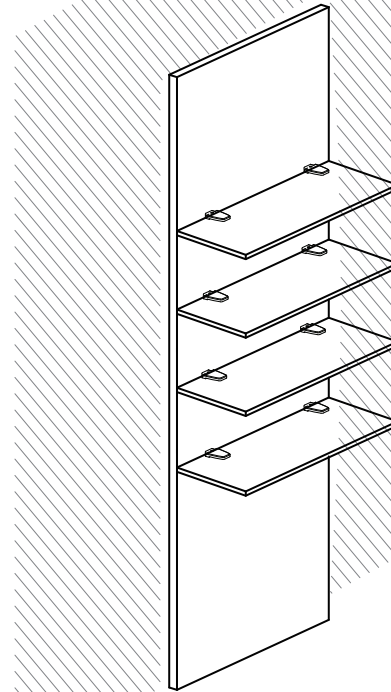
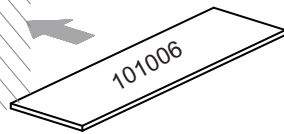
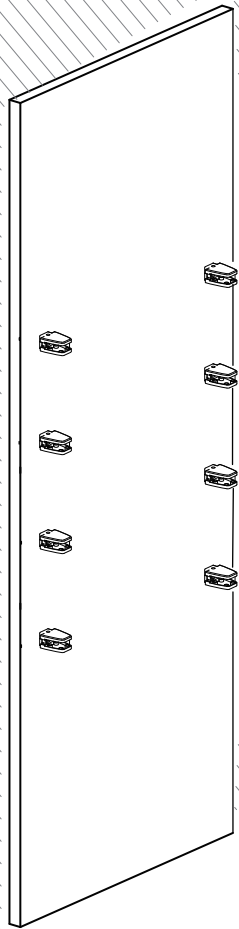



Brush away excess hair

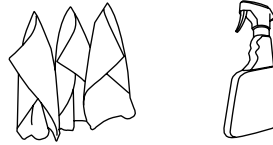

Clean surface with damp cloth or use simple soap & water solution.

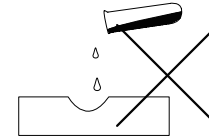

Avoid using corrosive cleaning agents such as bleaches.

Warranty

The warranty period is one year. DIR warrants to you, the original buyer, that goods shall be free of defects in material and/or workmanship attributable to manufacture for one year from date of receipt of product. Damage resulting from improper handling after merchandise is received, or from exposure to weather or extreme atmospheric conditions is not covered by the warranty. For any other information please contact our support team:

DIR BIRMINGHAM

66 Rea Street South
Birmingham
B5 6LB
UK

Tel:
+44(0)121 6434777

Email:
dirsalon@gmail.com

DIR LONDON

Unit 1 River Road
Business Park
33 River Road, Barking
Greater London
IG11 0DA
UK

Tel:
+44(0)20 8591 9310

Email:
dirsalon@gmail.com

DIR NEW YORK

575 Underhill Blvd.
Suite 170
Syosset, NY 11791
USA

Tel:
+1 (718)628-6668
+1 (800)728-2008

Email:
sales@dirsalonfurniture.com

DIR IRELAND

Unit 20, Goldenbridge Ind.
Estate Tyrconnell Road
Inchicore
Dublin 8
Republic of Ireland

Phone:
+353 (1) 429 7969

Email:
sales.ireland@dirgroup.ie